

## Small Hopper Multihead Weighers CCW-R-210 / 214 / 220

- Superior packaging of small target weights
- Precise weighing accuracy
- High speeds and operating efficiency
- Simple operator interface
- Easy-to-clean design
- Available in dry and washdown models

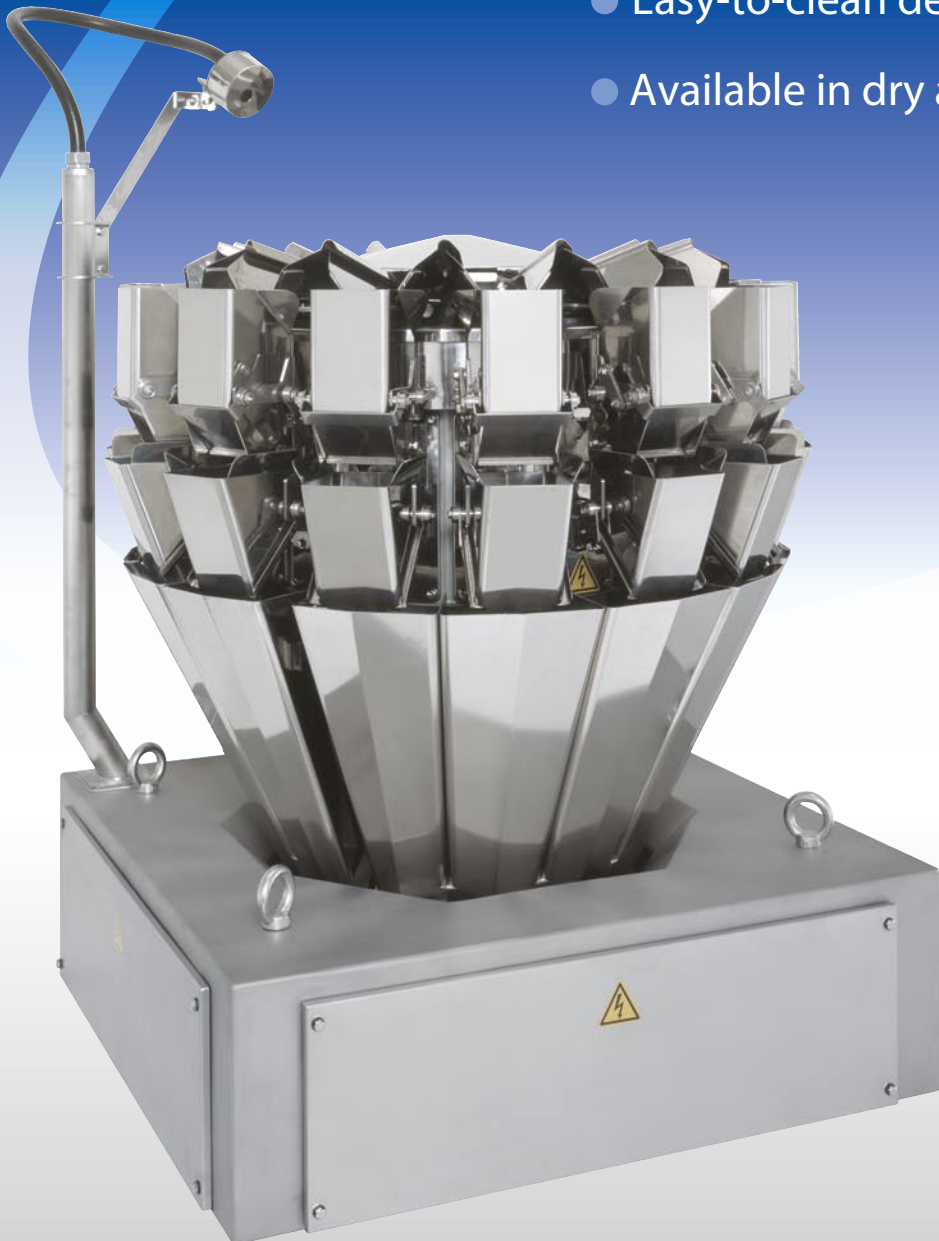



CCW-R-210W-S/08

DIMENSIONS (unit: mm)

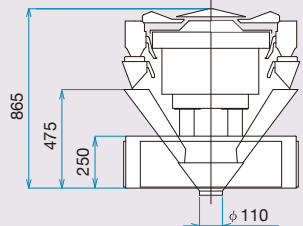
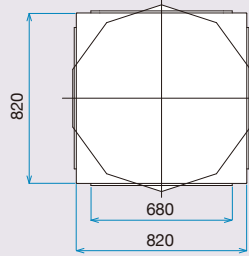

10-head CCW-R-210W-S/08

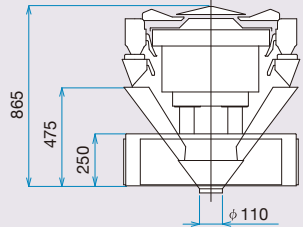
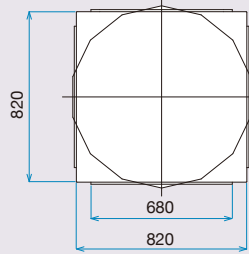

14-head CCW-R-214W-S/08

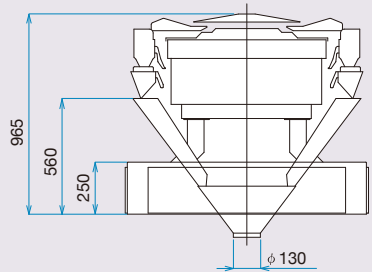
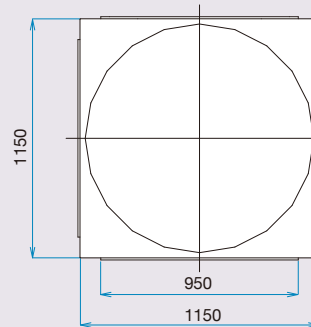

20-head CCW-R-220W-S/08

SPECIFICATIONS

Model	CCW-R-210W-S/05	CCW-R-210W-S/08	CCW-R-214W-S/05	CCW-R-214W-S/08	CCW-R-220W-S/05	CCW-R-220W-S/08		
Weighing Capacity/ Range (per single dump)	up to 500g	up to 500g	up to 500g	up to 500g	up to 500g	up to 1,000g	up to 500g	up to 1,000g
Weighing Accuracy (MAX)*	$\bar{X} < 0.5g - 1.0g$	$\bar{X} < 0.5g - 1.0g$	$\bar{X} < 0.5g - 1.0g$	$\bar{X} < 0.5g - 1.0g$	$\bar{X} < 0.5g - 1.0g$	$\bar{X} < 1.0g - 2.0g$	$\bar{X} < 0.5g - 1.0g$	$\bar{X} < 1.0g - 2.0g$
Maximum Volume for Weighing (per single dump)	0.75 litres	1.2 litres	0.75 litres	1.2 litres	0.75 litres	1.5 litres	1.4 litres	2.4 litres
Weighing Speed (MAX)**	100 WPM	100 WPM	200 WPM	200 WPM	70 WPM (2 mix)	70 WPM (2 mix)	70 WPM (2 mix)	70 WPM (2 mix)
Minimum Graduation	0.1 g	0.1 g	0.1 g	0.1 g	0.1 g	0.2 g	0.1 g	0.2 g
Touch Screen Display (RCU)	12.1" TFT Color LCD							
Weigh Cell	Double-beam strain gauge load cell							
Number of Presets	200							
Material	Product surfaces are made of stainless steel or other sanitary materials.							
Machine Weight	350 kg		400 kg		700 kg			
Options	Various options are available - Please contact Heat and Control.							
Structure of Waterproof Machines	IP66 Approval							
Air Consumption (Waterproof models)	110 L/min.(ANR) 0.5 Mpa Air hose -PT 3/8" (for air dryer connection) Note: Air compressor must be provided by the end user.							

Design and specifications are subject to change without notice.  
 \* Depends on target weight, weighing speed and conditions  
 \*\* Depends on product shape, product density, target weight, etc.

Ishida, the world leader in weighing technology, also manufactures a full line of checkweighers.



Specifications and design are subject to change without notice.



ISHIDA CO., LTD.

44 SANNO-CHO, SHOGOIN, SAKYO-KU  
 KYOTO, 606-8392 JAPAN  
 PHONE: 81-75-771-4141  
 FACSIMILE: 81-75-751-1634  
 URL: <http://www.ishidajapan.com>



HEAT AND CONTROL, INC.

21121 CABOT BLVD.  
 HAYWARD, CA 94545-1132 USA  
 PHONE: 1(800)227-5980  
 1(510)259-0500  
 FACSIMILE: 1(510)259-0600  
[www.heatandcontrol.com](http://www.heatandcontrol.com)  
[info@heatandcontrol.com](mailto:info@heatandcontrol.com)